



Green Cleaning For Health

Wm R. Griffin, President
Cleaning Consultant Services, Inc.



Introduction and Welcome

Sustainability and Green Are Not Trends, They Are the Future

Definitions

- **Green Cleaning:** Processes and products that have little or no negative, and hopefully a positive impact on the environment.
- **Sustainability:** Protecting the environment and natural resources.
 - Includes:
 - Green house gases
 - Carbon foot print
 - Life cycle costs
 - Resource Conservation



Green Cleaning is a Perfect Match for the
Cleaning Industry and the Millions of
Professional Who Maintain Commercial
and Residential Facilities

Even Birds Know Better Than to Poop in Their Nest



Seat of the Pants

- Appearance
- Tactile
- Odor
- Quantitative Evaluations
- The Way We Have Always Done it

Science Based Cleaning

- Research
 - What's it Telling Us?
 - Processes Don't Actually Clean
 - Testing
 - Quantitative Proof of Results
 - Technology
 - Education
 - Opportunity
 - An Evolving and Maturing Industry

Who's Certifying the Certifiers?

- Wild Wild West
- Jockeying For Position
- No Regulation
- No Accountability
- No Internationally Recognized Standard
 - Hundreds of Third Party Certifiers Worldwide

The Present

- A Time of Transition
- Never Been A Better Time to Be in the Cleaning Industry
- Challenges and Opportunity
- The Dawn of a New Era



Green, Sustainable Profitable and Effective

Green Cleaning Processes

- Low Moisture Processes
- Micro Fibers
- Dust Free
- Diamond Polishing Pads
- Odor Free
- Systems – Processes and Products

Green Floor Care

- No Heavy Metals
- Odor Free
- Scheduling and Frequency Reduction
- Finish Free
- Micro Fiber Flat Mops
- Resource and Waste Stream Reduction
- Vacuum Soil Removal – Wet and Dry

Green Carpet Cleaning

- Chemicals
- Low Moisture
- Prevention
- Frequency Reduction Focus on Micro Areas

Restrooms



The Big Picture

It's All Connected

- Cleaning
- Chemicals, Equipment and Products
- People
- Surfaces
- Maintenance
 - Pest Control
 - Grease, oil, paint, etc.
- Remodeling and Building

Reduction

- Resources
 - Money
 - Water
 - Chemicals
 - All Products
 - Energy
- Waste Stream
- Reuse and Recycling

Integrated Cleaning And Measurement (ICM)

**INTEGRATED CLEANING
& MEASUREMENT™**



Issues

- **Procedures** – How do we assure accurate and consistent testing and recording of data? Training, monitoring and analysis.
- **Application** – Does ICM impact quality, health, safety, cost and productivity?
Can we prove it? Does it cost or save money? ROI is it worth it?
- Are there other hidden benefits? **Image** – others and ourselves.
- **Results**- What do we do with the data? Why are we doing this? Goals?
- **Consistency** – How do we accomplish consistent testing, recording and data? Critical factor.
- **Analysis** – Manual and electronic collection – Data vs. Action – Overload.
- **Continuous Process Improvement** – How do we keep it going and improve it?

Quantitative vs. Qualitative

- **Quantitative:** Expressible as a quantity or relating to or susceptible of measurement.
- **Qualitative:** Descriptions or distinctions based on quality rather than on quantity.

The Tools and Equipment

- Do's and Don'ts - Testing Protocols
- Testing Focus and Reality
- Working with Recording Forms
- Policies, Procedures and Training
- Consistency is Critical

Inspection Tools

- A review of the current tools.
- List is growing, migrating from other industries.
- Being tested, used and written into specifications, contracts and procedures.
- Rudimentary starting place, but will grow in number and become more sophisticated in use and application.

Swabs

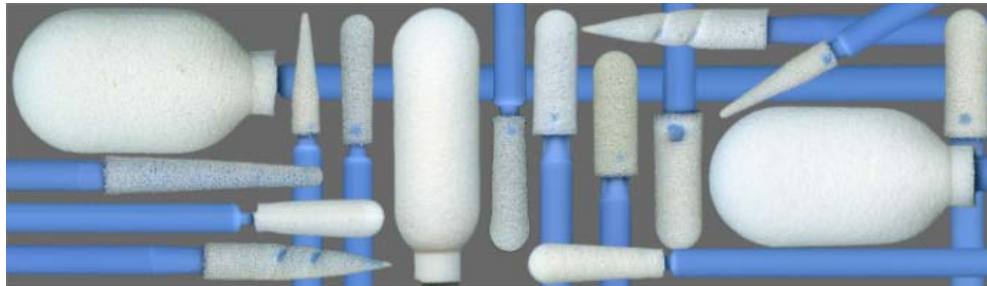

www.foamtecintlwcc.com

www.drugstore.com

Clear Scotch Tape



www.solutions.3m.com

Portable Microscope



www.radioshack.com

400 Power Computerized Electronic Microscope



Allergen Measurement



*DUSTREAM™ collector
+ adaptor*



*DUSTREAM™ collector
+ adaptor*

www.inbio.co.kr/dustream.html

Temperature & Humidity



Laser Thermometer



Infrared Camera



www.flirthermography.com

Standard Flashlight



UV (black) Lights



www.inspectoronline.com

www.professionalequipment.com

Inspector Online



www.inspectoronline.com

Calcium Chloride Moisture Test

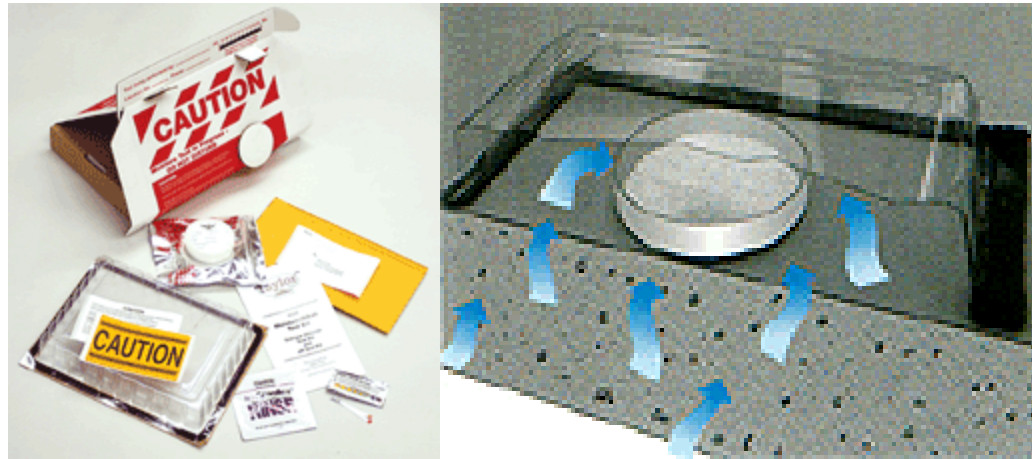

www.taylorflooringtools.com

Moisture Meters



www.protimer.com

www.moisturetesting.com

Slip Meter/Tribometer



www.noskid.com

www.reganscientific.com/301.html

www.nu-safe.com

Gloss, Film Thickness Meters



www.m3techinc.com

www.worldoftest.com

Conductivity/Resistivity Meter



Magnets



www.amazingmagnets.com

Mohs Hardness Test



RODAC Plates



www.pharmacal.com

Bacterial Cultures

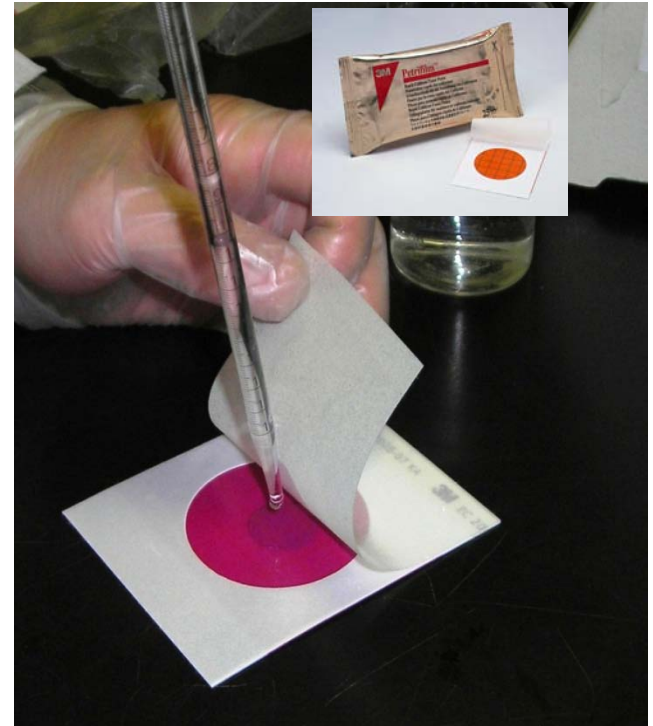
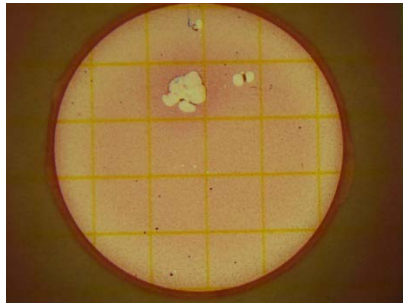

Fluorometer / Fluorometric Testing

Measures for Presence of Specific Micro-organisms



ATP Meter Luminometer

Measures Presence of Adenosine Triphosphate (ATP) which is found in organic matter, indicating possible biological contamination.

www.hygienea.net

www.bioreveal.com



ATP

- Different Types
- Realities
- Can Do – Can't Do
- Challenges
- Use and Cost
- Swabs, Use and Cost
- Data
- Use Instruction Video
- Cost, Meter & Swabs



www.kaivac.com/vid_2-ATP_Measurement

Biological or Organics Sampling

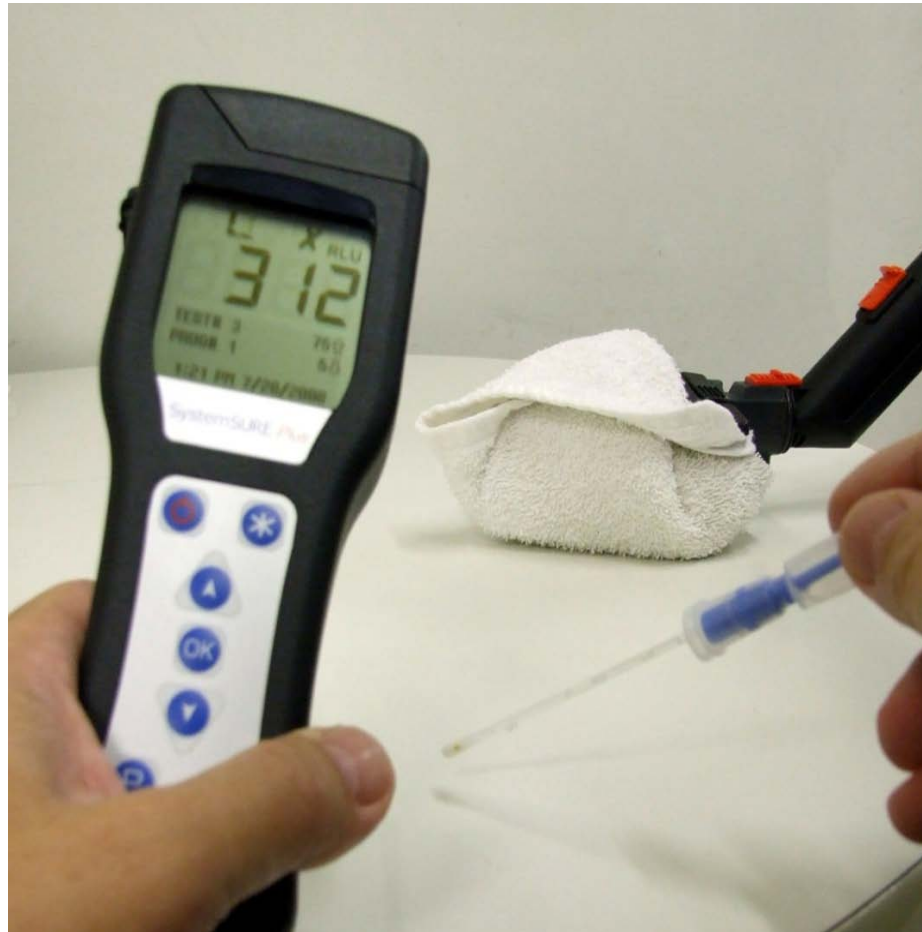

Proper Swabbing

- Remove a fresh swab from its tube (Temperature Sensitive)
- On flat surfaces:
 - Swab 4" x 4" area
 - Swab both horizontally & vertically
- On irregular surfaces
 - Swab enough of the surface to collect a good sample
- Rotate the swab between your fingers

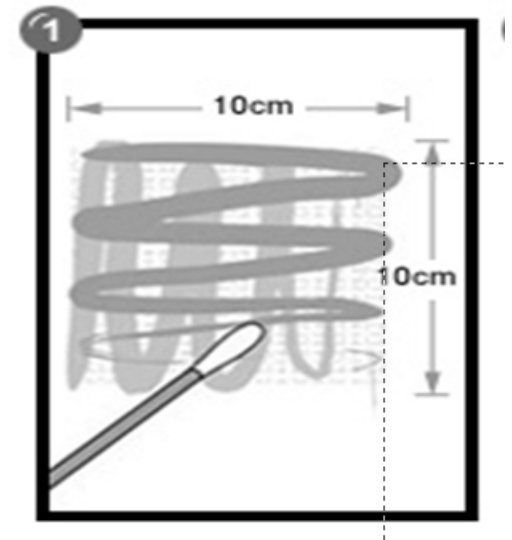

Consistent Approach for Irregular Surfaces





Integrated Cleaning & Measurement Data Report

Location: _____
Address: _____
City, ST Zip _____
Email Address _____

Inspected by: _____
Title: _____

Date: _____

ATP Test Results

| Method | Area | Surface Material | Good | Moderate | ATP Reading Before | ATP Reading After |
|---------------|----------------------------|------------------|------|----------|--------------------|-------------------|
| Restroom | Toilet Seat | | < 15 | < 30 | | |
| | Toilet Floor (avoid grout) | | < 20 | < 60 | | |
| | Soap Dispenser | | < 20 | < 60 | | |
| | Sink Handle | | < 15 | < 30 | | |
| Office/School | Desktop | | < 15 | < 30 | | |
| | Cafeteria Table | | < 15 | < 30 | | |
| | Countertop | | < 15 | < 30 | | |
| | Lab Table | | < 15 | < 30 | | |
| | Front Desk | | < 15 | < 30 | | |
| | Wrestling Mat | | < 50 | < 100 | | |
| | | | | | | |
| | | | | | | |
| | | | | | | |
| | | | | | | |

SureTrend Data Display

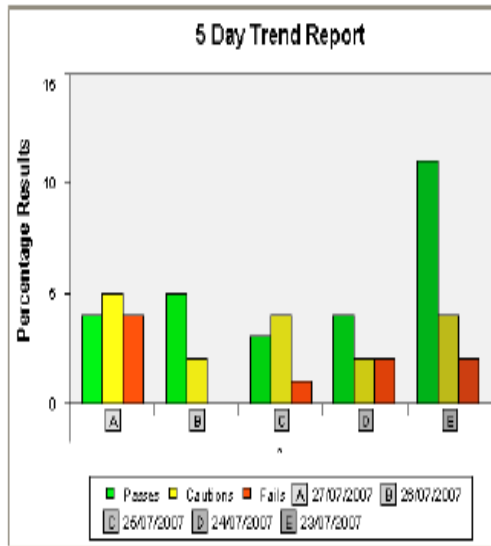

Bar

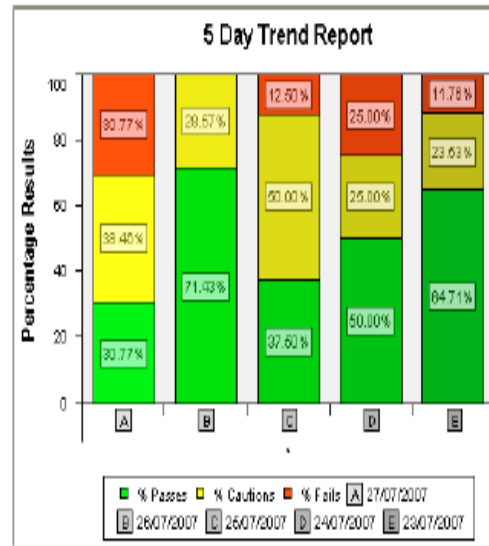

Stacked

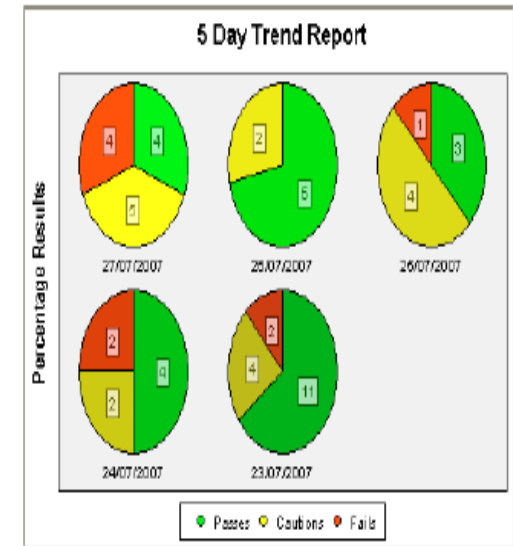

Pie

Mold Test

QUICK MOLD TEST

PROUDLY MADE IN THE U.S.A.

FASTEST Mold Test in the World!

Detect **DANGEROUS MOLD** in less than 1 Minute!

INSTANTLY TEST FOR MOLDS INCLUDING:
Aspergillus
Bipolaris
Fusarium
Penicillium
Stachybotrys
Yeast & MORE!

Easy to Use - Fast Results

Package Contains:
2 Quick Mold Tests

PASS FAIL FAIL FAIL

Results Key

How to Use

- 1 Swab
- 2 Snap & Squeeze
- 3 Results

Test results positive? Log on to www.QuickMoldTest.com for help!

www.quickmoldtest.com

Lead Test



www.professionalequipment.com

Particle Counter



X-Ray Fluorescence (XRF)



Color Meter



www.bykgardner.com
www.konicaminolta.com

Odor Analysis



www.biotector.com

Z-Nose - Odor Analysis



www.estcal.com

Indoor Air Quality Meter

Optima Monitor Measures 9 Key Parameters:

- Temperature
- Relative humidity
- Carbon dioxide
- Small particles
- Large particles
- Carbon monoxide
- Radon
- Ozone
- Total Volatile Organic Compounds (TVOC)



CFM Thermo-Anemometer



Carbon Monoxide Detector



www.professionalequipment.com

Carbon Dioxide Meter



Decibel Meter



www.radioshack.com

UV Meter



www.solarmeter.com

Mini Light Meter



Tuft Bind Test



Laser Square

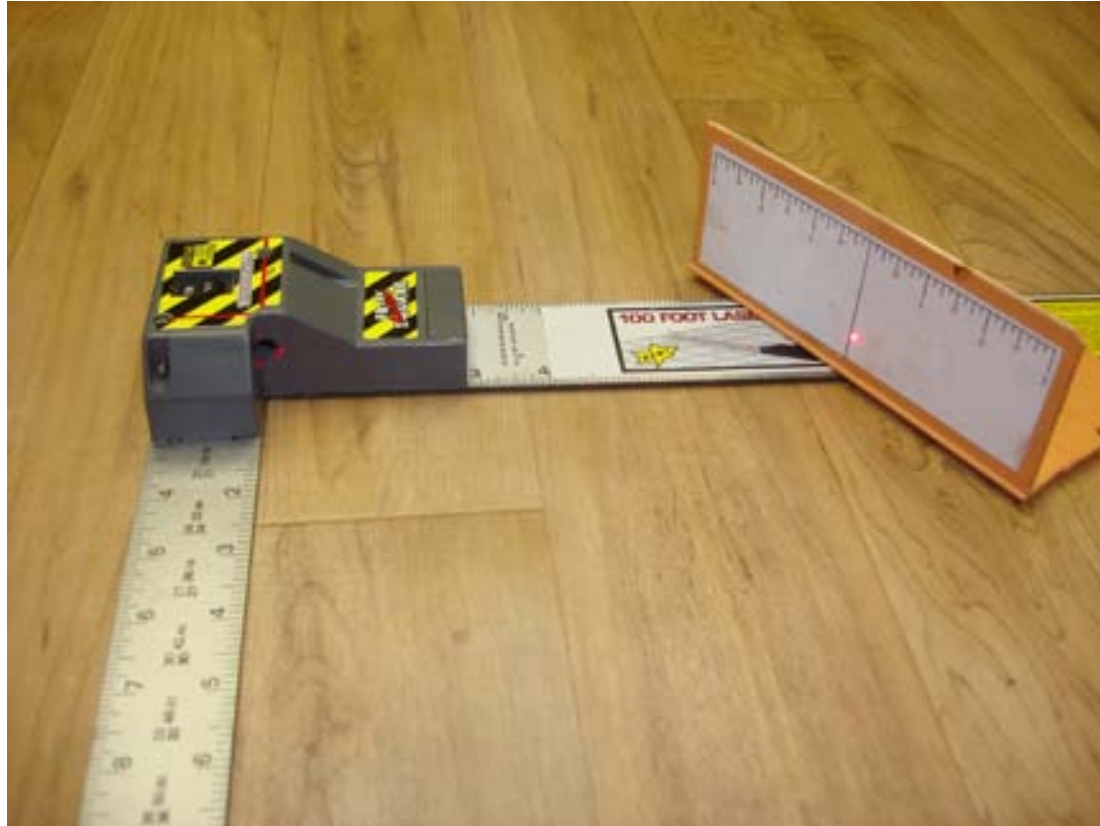

Laser Level



Distance Meter



www.professionalequipment.com

Dust, Soil and Particle Analysis

| | | |
|---|--|---|
| <p>ASBESTOS LAB SERVICES</p> | <p>BACTERIA AND MOLD LAB SERVICES</p> | <p>ENVIRONMENTAL CHEMISTRY LAB SERVICES</p> |
|  |  |  |
| <p>HOMEOWNER SERVICES</p> | <p>INDOOR AIR QUALITY LAB SERVICES</p> | <p>INDUSTRIAL HYGIENE LAB SERVICES</p> |
|  |  |  |
| <p>LEAD LAB SERVICES</p> | <p>PRODUCTS TESTING AND FORENSIC LAB SERVICES</p> | |
|  |  | |
| <p>Los Alamitos 1-800-755-1794</p> | | <p>South Pasadena 1-800-303-0047</p> |

Ph Test Papers



www.phionbalance.com

www.professionalequipment.com

Disinfectant Test Papers



www.viroxtech.com

www.indigo.com

www.lamotte.com

Sanitizer & Chlorine Test Papers



Urine Test Strips



www.anytestkits.com/urine-tests.htm

Water Hardness Test



www.hardwatertest.com



www.spritewater.com/test.htm

Taber Abrasion



Borescope



Advanced Testing Processes

- Petrographic analysis
- X-ray diffraction analysis (XRD)
- Differential thermal analysis and thermogravimetric analysis (DTA/TGA)
- Infrared analysis (IR)
- Scanning electron microscopy/energy dispersive X-Ray analysis (SEM/EDXA)
- Spectroscopic analysis
- Chemical analysis

Catalogues & Websites

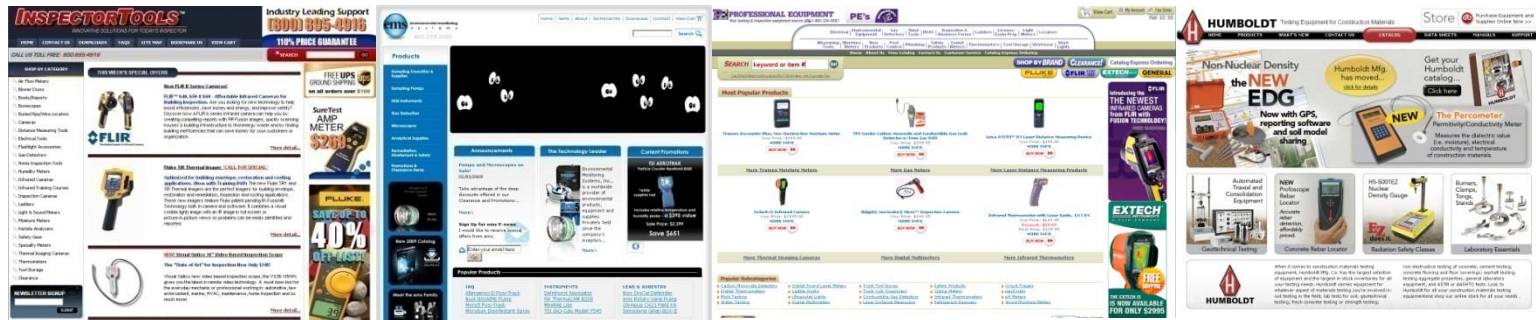

www.professionalequipment.com

www.inspectortools.com

www.emssales.net

www.ehumboldt.com

www.fluorovei.com/

www.inbio.com/US/index.php

www.golighthouse.com/

www.vistaenterprisesinc.com/index.htm

How to Implement ICM Testing

- Commitment, goals and timeline
- In writing
- Share and Involve everyone/other groups
- Start the process – small and easy first

The Process

- Decision
- Research
- Customization
- Training
- Begin Testing
- Data Collection and Analysis
- Process Improvement
- Application
- Ongoing Process Improvement based on Science

Inspection, Testing, Measurement and Validation

- What the Science is Telling Us
- Trends, Today & Tomorrow
- Return on Investment (ROI)

ICM Resources

- www.ieha.org
- www.cleaningconsultants.com
- www.issa.com (CIMS)
- www.iicrc.org (Standards)

Production Rates

- ISSA's Official 540 Cleaning Times

Can be purchased on www.ieha.org or www.issa.com.

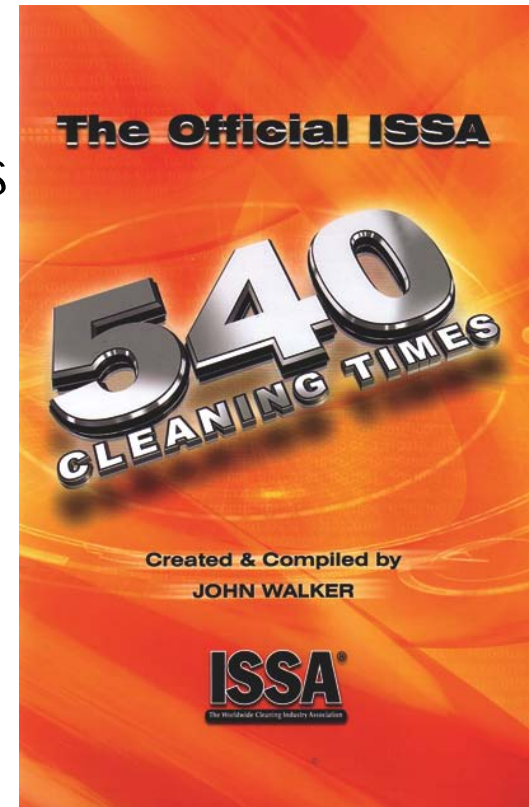



Consultants

- William Griffin
wgriffin@cleaningconsultants.com
- Vince Elliott
www.ealtd.com
- Dr. Charles Gerba
gerba@Ag.arizona.edu
- R.W.Powitz & Associates
www.sanitarian.com

ICM Process & Overview

- http://www.jantrain.com/resources/ICM_101/engage.html
- http://www.jantrain.com/resources/ICM_Process/engage.html

ICM at the University of Washington

- www.jantrain.com/resources/UW_Pre_Pilot_Media_Tour_July_2009/engage.html
- www.jantrain.com/resources/UW_Product_Tests_01/engage.html



Indoor Air Quality Resources

- American Indoor Air Quality Council www.indoor-air-quality.org
- American Industrial Hygiene Association www.aiha.org
- American Lung Association www.lungusa.org
- Amer. Soc. of Heating, Refrig. & Air Cond. Engineers www.ashrae.org
- Center for Disease Control / NIOSH (CDC / NIOSH) www.cdc.gov/niosh
- Indoor Air Quality Association (IAQA) www.iaqa.org
- Indoor Environmental Connections www.ieconnections.com
- National Air Duct Cleaners Association (NADCA) www.nadca.com
- National Air Filtration Association www.nafa.org
- Occupational Safety & Health Administration (OSHA) www.osha.gov
- University of Tulsa Indoor Air Program www.utulsa.edu/iaqprogram
- U.S. Environmental Protection Agency (EPA) www.epa.gov/iaq



The Market and Reality

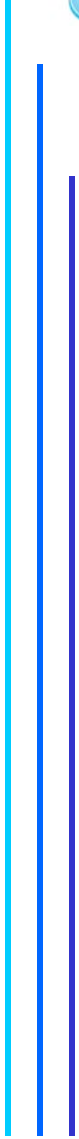

Keeping Up with Tomorrow

- Seminars
- Books
- Videos
- Internet
- Peers
- Responsibility

Education is the Answer

- Income
- Security
- Advancement
- Opportunity
- Satisfaction
- DIY Video, Good and Bad
- Edutainment and 2nd Life

Hands On Training



The Future

- Industry Trends
- How They Will Impact You
 - Equipment
 - Chemicals
 - Supplies

Manufacturers, Suppliers, Distributors

- Evolving
- Like other industries
- Natural Process
- A Valuable Resource

End Users, Cleaners, Society and the Environment

- Next Generation is Here
- Workforce is Aging
- Numbers of Workers Shrinking
- What Do We Offer As An Industry
- Need to Sell the Opportunity Not the Job

Green Resources

- www.issa.com
 - International Sanitary Supply Association (ISSA)
 - Cleaning Industry Management Standard – Green Buildings (CIMS-GB)
 - Green Cleaning University (GCU) and Green Cleaning Professional (GCP)
 - Information Based Environmental Labeling Program (IBEL)
 - Publications on Green Cleaning
- www.greenseal.org
 - Information on it's standards and certification programs for: Industrial Cleaning Chemicals (GS-37) Floor Care Products (GS-40), Paper Towels (GS-9), Tissue Paper (GS-1) Environmentally Preferable Cleaning Services (GS-42), Lodging Properties (GS-33), Restaurants and Food Service (GS-46), Specialty Cleaning Products (GS-52)
- www.usgbc.org
 - Information on the Leadership in Energy and Environmental Design (LEED) certification program.(LEED-EB-OM and other standards)
- www.epa.gov/epp/pubs/cleaning.htm
- www.epa.gov/dfe/standard_for_safer_cleaning_products.pdf
 - Design for the Environment Program (DfE) (Green Product Recognition)
- www.EcoLogo.ca

Green Resources

- www.environmentalchoice.com/en/index.asp
 - North American/Canadian program for green standards (EcoLogo) and certification of chemicals, paper products and related items. Multiple CCD standards issued.
- www.GreenGuard.org
 - GREENGUARD Environmental Institute (GEI) oversees 3rd party certification programs for product emissions and Indoor Air Quality. (IAQ)
- www.ashkingroup.com
 - Industry consulting firm that provides information, publications and software related to green cleaning and offers free subscription to it's Destination Green e-newsletter. Founded by Steve Askin and David Holly.
- www.carpet-rug.org
 - Carpet and Rug Institute (CRI)
 - Seal of Approval (SOA) Program for the certification and recognition of firms, equipment, chemicals and processes related to carpet and fabric cleaning.
- www.ieha.org
 - High Performance Cleaning Product (HPCP) program to certify or recognize green certified or recognized products that meet minimum performance standards.
- www.ulenvironment.com
 - Underwriters Laboratories Environment (ULE) Claims Validation Program (ECV)

Green Resources

- www.scscertified.com
 - A private company offering third party certification services.
- www.greenhotels.com
 - Information on applying green processes to the hospitality industry.
- www.dinegreen.com
- Information on the Green Restaurant Association's certification program, services and publications.
- www.ifma.org
- Offers the book "The Business of Green Cleaning and related information and services to commercial property managers.
- www.noharm.org
 - Health Care Without Harm Organization (HCWH) offers a free Going Green Resource Kit and other information for health care facilities.
- www.gghc.org
- Green Guide for Health Care offers tools and resources on greening health care facilities.
- www.westp2net.org
 - An informational resource on pollution prevention and green cleaning issues.

Green Resources

- www.newdream.org
 - A source for green info
- www.arb.ca.gov/cc/ccei.htm
 - California Air Resources Board (CARB)
- www.healthyschools.com
- www.chps.net
 - Info on High Performance Green Schools
- www.tennantco.com
 - Manufacturer of cleaning equipment that utilize cutting edge technologies such as ionized and oxygenated water for chemical free cleaning, foam, and super concentrates.
- www.activeion.com
 - Manufacturer of hand held spray units that utilize ionized water and oxygenated water for chemical free cleaning and sanitization.
- www.orkin.com/downloads/commercial/Green%20Pest%20Management%20Checklist.pdf
 - Information on it's Green Pest Control Gold Metal Protection Program
- www.envirodesic.com
 - A private company offering third party green certification.
- www.managemen.com
 - A private company that audits and provides OS1 Green Certification to organizations based on it's OS1 cleaning management program.
- www.aslett.com
 - A private company offering it's "Clean Green World" 3rd party evaluation service.

How Are You Going To Fit In?

- Passion and Pride
- What are you going to do with what you know?
- When?
- What difference is it going to make?



Thank You

Question and Answer Period



Contact Information

- William R. Griffin
- Cell- 206-849-0179
- www.cleaningconsultants.com
- wgriffin@cleaningconsultants.com